

# MICROPROCESSOR – BASED WATER TREATMENT CONTROLLER

## Quick Start INSTALLATION MANUAL

*Cooling Tower 9200, 9300, 9500 Series*

1. INSTALLATION LOCATION: COOLING TOWER.....	3
1.1 Cooling Tower .....	3
1.1.1 Installation Notes .....	3
1.2 Electrical Wiring .....	4
1.2.1 User Connections.....	5
1.3 Front Panel .....	9
2. CONTROLLER SET UP 9200 SERIES .....	10
2.1 Initialization .....	10
2.2 Menu Structure.....	10
2.3 Key Pad Operation .....	11
2.4 Screen Format .....	12
3. 9300 & 9500 SERIES.....	14
3.1 Menu Structure.....	15
3.2 Keypad Operation .....	16
3.3 Screen Format .....	17
3.4 Change Verification.....	18
4. ALTERNATE LANGUAGE.....	18
5. FACTORY DEFAULT VALUES .....	20
6. STANDARD SENSORS: .....	23
6.1 Cooling Tower Sensors.....	23
6.2 Hi-Pressure Sensors .....	23
7. SPECIFICATIONS.....	24
7. SPECIFICATIONS .....	25
8. MAINTENANCE .....	27
9. RELAY ASSIGNMENTS .....	27
9.1 Cooling Tower .....	27

# 1. Installation Location: Cooling Tower

Select a mounting location convenient to grounded electrical and plumbing connections. Mount the controller on a wall or other vertical surface with adequate lighting at a comfortable level. Installation must comply with all national, state and local codes.

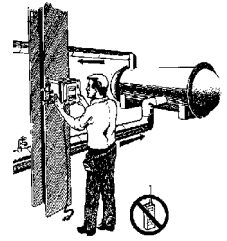

## 1.1 Cooling Tower



**AVOID LOCATIONS WHERE THE CONTROLLER WOULD BE SUBJECTED TO EXTREME COLD OR HEAT [ $<$  THAN  $0^{\circ}\text{F}$  ( $-17.8^{\circ}\text{C}$ ) OR  $>$  THAN  $122^{\circ}\text{F}$  ( $50^{\circ}\text{C}$ )], DIRECT SUNLIGHT, VIBRATION, VAPORS, LIQUID SPILLS OR EMI (ELECTROMAGNETIC INTERFERENCE; I.E., STRONG RADIO TRANSMISSION AND ELECTRIC MOTORS.) THE CONTROLLER COULD BE DAMAGED AND VOID THE WARRANTY!**

### 1.1.1 Installation Notes

1. Install sensors{ XE "sensors" } or sample stream flow assembly at some point before chemical injection points where chemical and water are thoroughly mixed (see *Figure 3*).
2. Measuring surfaces of the sensor electrodes{ XE "electrodes" } must be continuously immersed in system water.
3. The difference between the inlet and output pressure must be sufficient to provide a flow rate between 1 to 5 GPM (3.81 to 19.05 l/m) to assure water will flow past the sensors{ XE "sensors" } and they will read properly.
4. Most solenoid valves require a pressure differential{ XE "differential" } of 7 psi (0.48 BAR) to 15 psi (0.96 BAR) to close; if this is not available, install a zero pressure solenoid valve if blowdown is incorporated.
5. If chemicals are to be injected into sample line, always use a back check valve to prevent chemicals from backing up around sensors{ XE "sensors" }.
6. If a flow assembly or sample stream assembly is present, never install a blowdown valve{ XE "blowdown valve" } off these lines. The system will not achieve proper blowdown and accuracy of controller readings may be affected.

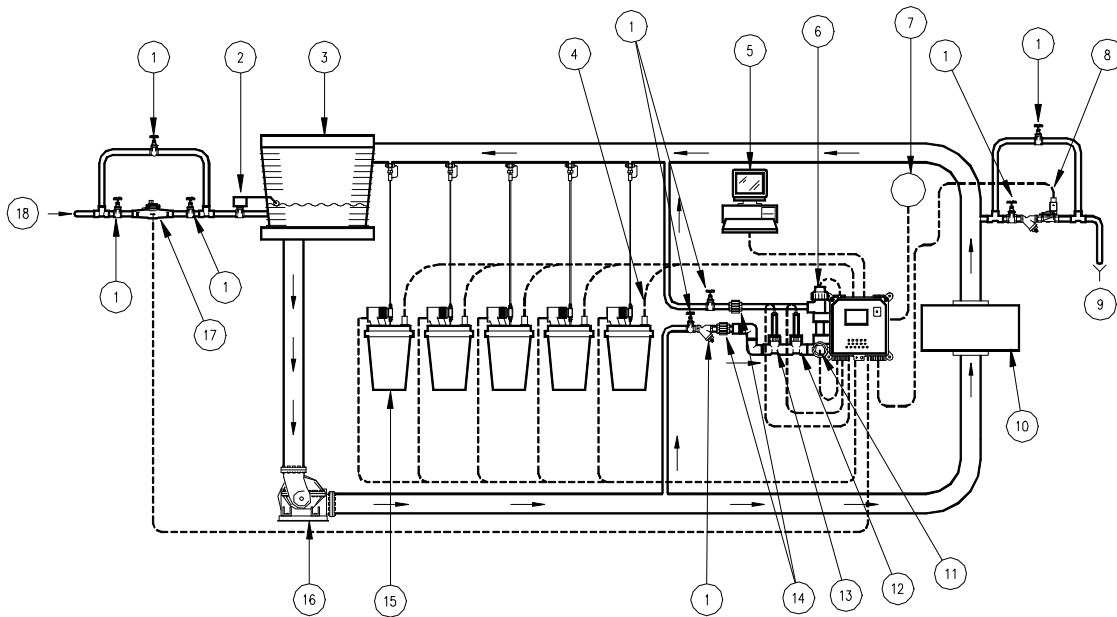

Figure 3 – Typical Installation Cooling Tower

1	Isolation Valve	10	Heat Exchanger
2	Float Valve	11	Conductivity Sensor
3	Cooling Tower	12	pH Sensor
4	Drum Level (Typ.)	13	Redox (ORP) Sensor
5	Computer for remote access	14	Union
6	Flow Switch	15	Chemical Feed tank
7	Alarm	16	Feed Water Pump
8	Blow Down Solenoid Valve	17	Water Meter
9	Drain	18	Municipal Water Inlet



The standard flow assembly, is constructed of durable glass filled polypropylene (GFPP). Connection to the flow line is 3/4" NPT (19.05 mm). A PVC thread to slip adapter is provided so that a PVC weld joint, if preferred, can be made.

## 1.2 Electrical Wiring

**UNIT MUST BE WIRED IN ACCORDANCE WITH ALL APPLICABLE ELECTRICAL CODES.**



The controller electronic circuitry is fuse protected. In addition, each output relay is individually protected by a replaceable plug-in 5 amp fuse on the relay board{ XE "relay board" }. Use of a surge protector is strongly recommended! The device should satisfy the following minimum requirements:

Response: <1ns  
 Energy Dissipation: 400 Joules  
 EMI/RFI Noise Attenuation: 5-35dB



**The controller should be connected to its own 15 amp power branch (i.e., its own wiring, circuit breaker, etc.). For best results, the ground should be independent (true earth) not shared.**

Pre-wired units are supplied with 6 ft (1.8 m), 18 AWG (1.2 mm<sup>2</sup>) 3-wire grounded power cords and clearly marked 18 AWG (1.2 mm<sup>2</sup>) 3-wire grounded receptacle cords for all controlled line voltage outputs.

Use 16 AWG (1.5 mm<sup>2</sup>) or 18 AWG (1.2 mm<sup>2</sup>) wire for conduit power and load connections.

## 1.2.1 User Connections



**LINE VOLTAGE IS PRESENT ON THE POWER SUPPLY LOCATED BEHIND THE SAFETY COVER BEHIND THE FRONT PANEL. LINE VOLTAGE IS ALSO PRESENT ON THE RELAY BOARD{ XE "RELAY BOARD" } LOCATED IN THE BOTTOM OF ENCLOSURE, EVEN WHEN POWER IS OFF. POWER MUST BE DISCONNECTED WHILE CONNECTIONS ARE BEING MADE!**

### 1.2.1.1 Power



**The controller should be connected to its own 15 amp power branch (i.e., its own wiring, circuit breaker, etc.). For best results, the ground should be independent (true earth) not shared.**

Connect the incoming power to J12 on the Relay Board located at the bottom of the enclosure. Connect the Neutral to position '1' labeled 'RTN.' Connect the Earth Ground to position '2' labeled with the earth ground symbol . Connect the Line to position 3 labeled 'HOT.' Use minimum 18 AWG (1.2 mm<sup>2</sup>) wire.

The control circuit is fuse protected. In addition, each output relay is individually protected by a replaceable plug-in 5 amp fuse (P/N: 05-051-82) on the relay board{ XE "relay board" }.



**BEFORE APPLYING POWER, INSURE THAT DEVICES BEING CONTROLLED ARE NOT IN A POSITION TO CAUSE HARM OR DAMAGE IF ACTIVATED UPON INITIAL START-UP.**

### 1.2.1.2 Relay Connections

Relay connections are made to J3, J4, J5, J6, J7, J8 and J9. Use only 16 or 18 AWG (1.5mm<sup>2</sup> or 1.22mm<sup>2</sup>) wire. Both normally open and normally closed powered contacts are available. To complete the wiring, first locate your model number. Then note the relay positions and associated functions. Wire your blowdown device (e.g., motorized ball valve) to the appropriate position. Note all outputs are powered at line voltage and fused at 5A. Many motorized ball valves require connections to both the Normally Open (NO) and Normally Closed (NC) terminals.

### 1.2.1.3 Flow Switch or Interlock



It is recommended that a flow switch or auxiliary dry contact from the control panel be used to make outputs inoperative when the cooling tower is shut down. This connection is provided on all standard units.

### 1.2.1.4 Sensor Connections

Units come from the factory with all sensors{ XE "sensors" } pre-connected. Use of unapproved sensors will void the warranty.



**For proper rejection of AC line voltage spikes, sensor EMI noise rejection and personal safety, the case ground (SAFETY GROUND) must be properly installed. If there is ANY doubt, consult a qualified electrician.**

### 1.2.1.5 Inputs/Output Connections

(Water Meter (for Pulse Timer) / Drum Level / Alarm Dry Contact / 4-20mA)

Internal electrical wiring is not required for water meters, single point drum level sensors, alarm dry contact or 4-20mA inputs or outputs. Accessory cables are available for connection.

### 1.2.1.6 Receptacles

Non-CE Controllers are offered in a unique pre-wired package as standard. Each cord is clearly marked and readily accessible for connecting external electrical devices to be controlled.

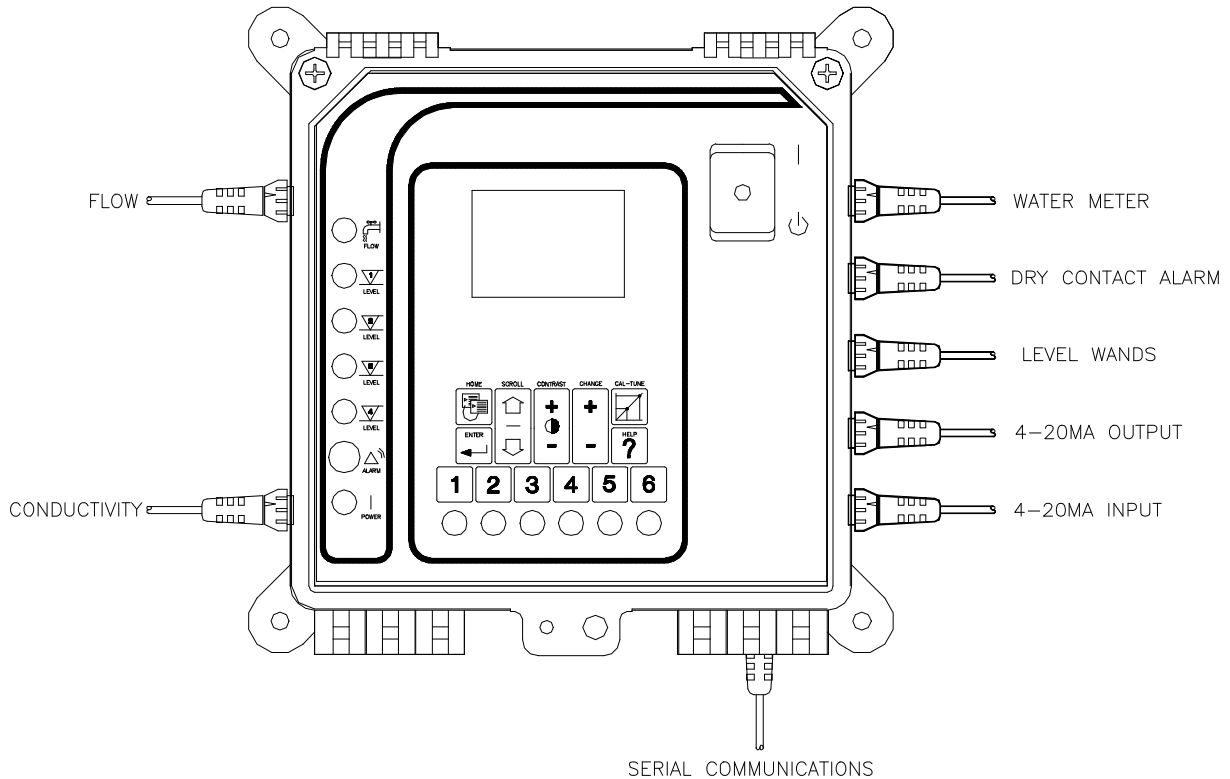

\* Excluding Sensors & Serial Communications, Cables shown connected to the enclosure are accessories and must be ordered separately.

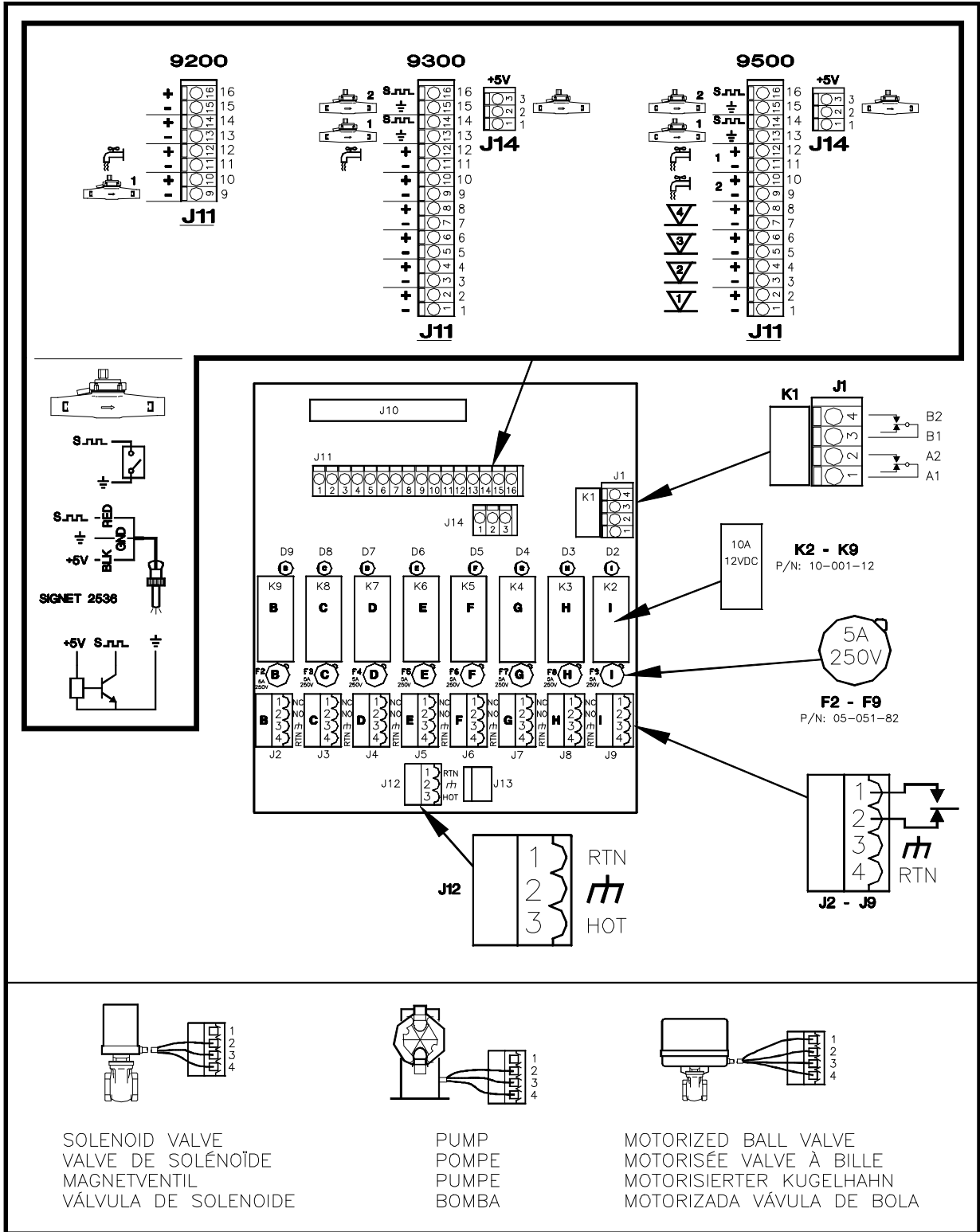

Figure 4

# CABLE WIRING INSTRUCTIONS

## 4-20mA OUTPUT

DIN CONN. PIN #	TWISTED PAIRS	WIRE COLOR	4 - 20 mA OUTPUT(S)
1	1	Red	OUT #1 (+)
2	1	Black/Red	OUT #1 (-)
3	2	White	OUT #2 (+) opt.
4	2	Black/White	OUT #2 (-) opt.
5	3	Green	OUT #3 (+) opt.
6	3	Black/Green	OUT #3 (-) opt.
7	4	Blue	OUT #4 (+) opt.
8	4	Black/Blue	OUT #4 (-) opt.

## 4-20mA INPUT (9500)

DIN CONN. PIN #	TWISTED PAIRS	WIRE COLOR	4 - 20 mA INPUT(S)
1	1	Red	IN #1 (+)
2	1	Black/Red	IN #1 (-)
3	2	White	IN #2 (+) opt.
4	2	Black/White	IN #2 (-) opt.
5	3	Green	IN #3 (+) opt.
6	3	Black/Green	IN #3 (-) opt.
7	4	Blue	IN #4 (+) opt.
8	4	Black/Blue	IN #4 (-) opt.

## DRUM LEVEL WANDS (9500 only)

DIN CONN. PIN #	TWISTED PAIRS	WIRE COLOR	DRUM LEVEL WANDS
1	1	Red	LEVEL #1
2	1	Black/Red	LEVEL #1
3	2	White	LEVEL #2
4	2	Black/White	LEVEL #2
5	3	Green	LEVEL #3
6	3	Black/Green	LEVEL #3
7	4	Blue	LEVEL #4
8	4	Black/Blue	LEVEL #4

## DRY ALARM CONTACTS

DIN CONN. PIN #	TWISTED PAIRS	WIRE COLOR	DRY CONTACT
1	1	Red	RELAY #1
2	1	Black/Red	RELAY #1
3	2	White	RELAY #2
4	2	Black/White	RELAY #2
5	3	Green	N/A
6	3	Black/Green	N/A
7	4	Blue	N/A
8	4	Black/Blue	N/A

## WATER METER\*

DIN CONN. PIN #	TWISTED PAIRS	WIRE COLOR	HALL EFFECT	DRY CONTACT
1	1	Red	METER #1+5V	
2	1	Black/Red	METER #2+5V	
3	2	White	METER #1 SIG.	METER #1
4	2	Black/White	METER #1 GND.	METER #1
5	3	Green	METER #2 SIG.	METER #2
6	3	Black/Green	METER #2 GRD.	METER #2
7	N/A	Blue	N/A	N/A
8	N/A	Black/Blue	N/A	N/A

Use these tables to connect your device(s) to the controller. First, locate the DIN connector labeled for your device, e.g. "WATER METERS" on the right side of the controller and attach your cable. Next, find the applicable table. For example: If you have (2) two Dry Contact Water Meters, refer to the **Water Meters Table - Dry Contact Column**. Find the first twisted pair that has a WHITE and BLACK/WHITE wire and connect these to Water Meter #1. Next find the second twisted pair that has a GREEN and BLACK/GREEN wire and connect these to Water Meter #2.

\* HALL EFFECT AVAILABLE ON 9300/9500 SERIES ONLY

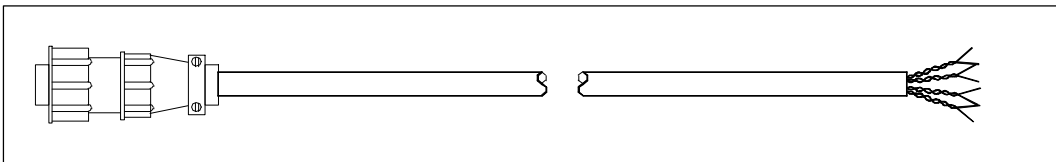



## 1.3 Front Panel

Take a moment to review diagram and become familiar with the controller front panel.

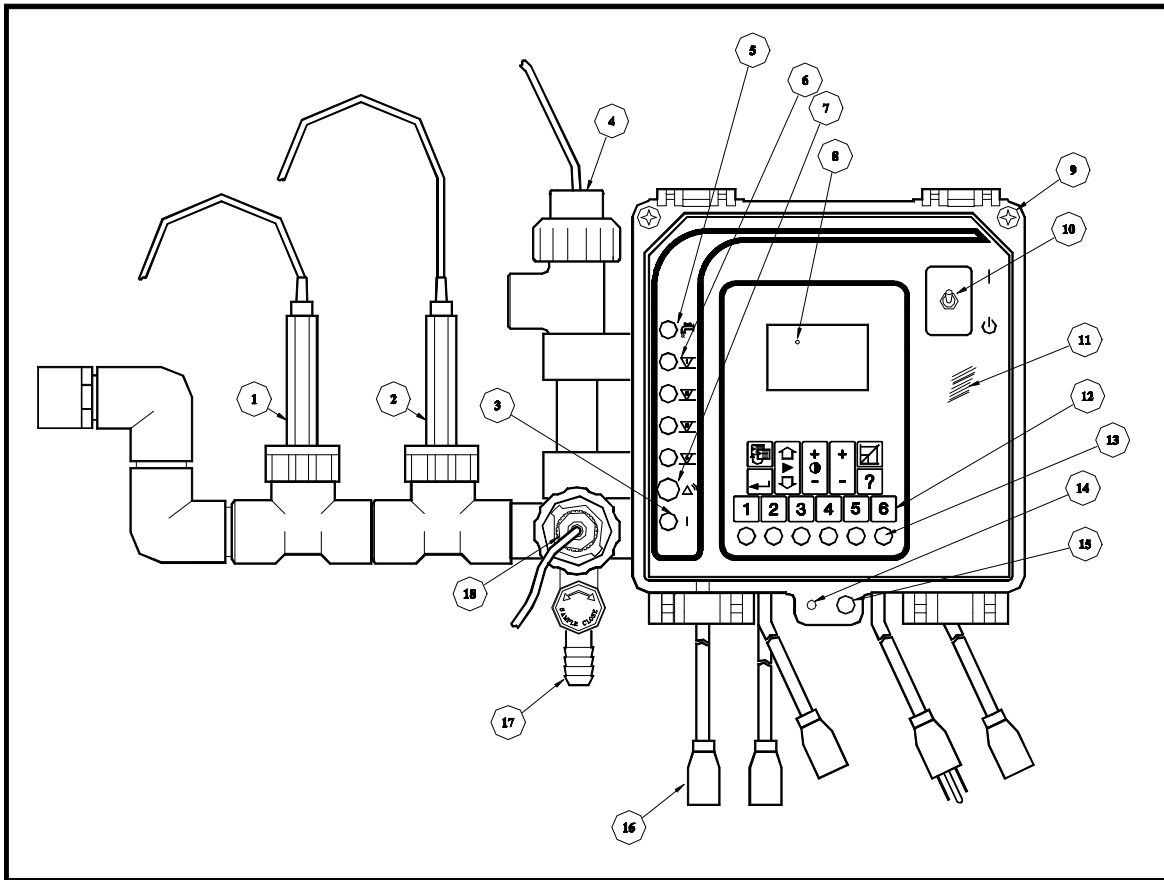

Diagram: Front Panel

Figure 5

1	Redox (ORP) Sensor	10	Logic Power Switch
2	pH Sensor	11	Cover
3	Power LED	12	HOA Switches
4	Flow Switch	13	Relay Indicators
5	Flow LED	14	Provision for Lock
6	Level LED	15	Thumb Screw
7	Alarm LED	16	Pigtail (Non-CE Units)
8	Display	17	Sample Valve
9	Panel Screws	18	Conductivity Sensor

## 2. Controller Set Up 9200 Series

### 2.1 Initialization



**BEFORE APPLYING POWER, INSURE THAT DEVICES BEING CONTROLLED ARE NOT IN A POSITION TO CAUSE HARM OR DAMAGE IF ACTIVATED UPON INITIAL START-UP.**

Note: If unit has been disconnected from power for a long time period (more than 2 weeks), when powered up the display may indicate charging with a percent value. When adequately charged, the display will **AUTO SCROLL** to **MAIN MENU**.

Unit requires initialization upon start-up. Before applying power, insure that devices being controlled are not in a position to cause harm or damage if activated upon initial start-up. With the controller now installed in a convenient location, **INITIALIZE** the Controller. Supply power to the controller and turn the Logic Power switch on. The power LED indicator light will be illuminated. When controller is powered up, the **MAIN MENU-DISPLAY DATA** (shown below) will be displayed.:

1. Press **SCROLL DOWN** until **MAIN MENU-CONFIGURE** is displayed and press **ENTER**.
2. Press **SCROLL DOWN** until **CONFIGURE-FACTORY REINIT** is displayed and press **ENTER**.
3. The Factory Re-Init Warning will be displayed. Continue to scroll down to the end of the warning and then press **ENTER**. Press the **ENTER** key to execute Factory Re-initialization. The unit will revert to **AUTO SCROLL**. Press the **HOME** key repeatedly to return to the **MAIN MENU**. **NOTE:** You may need to adjust the contrast after completing factory reinit!

### 2.2 Menu Structure

The Controller menu structure as well as the hardware were designed with the user in mind. The “MENU MAP” supplied on the CD Rom with your controller reflects your specific system with options.

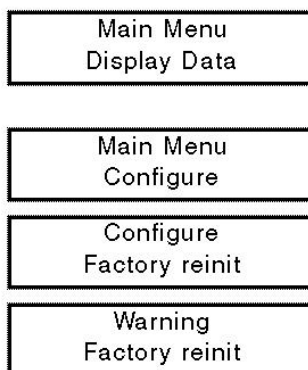

**Display Data** This menu displays system parameters only. No settings or adjustments are made through this menu. Present System Conductivity and System pH conditions are displayed along with any active alarms.

**Calibrate Sensor(s)** This menu is for analog input sensor calibration, such as conductivity and pH. In this menu, the user is prompted to choose either 2 or 3 point calibration. After a choice is made, the user is prompted to enter values of LO, MID (if 3 point is chosen) and HI calibration solution.

**Set Points and Alarms** In this menu, the user is prompted to enter settings pertaining to alarms and set points that control the system operation.

**Inhibitor Feed Set** In this menu, the user is prompted to enter settings pertaining to the inhibitor feed mode chosen in the System Configure menu.

**Biocide Programs** In this menu the user is prompted to enter all settings pertaining to the biocide program timer.

**System Configure** This is generally the first selection made at start up. In this menu, the user is prompted to configure system functions and options to your specific application. System Configure can include such things as time of day, week, date, security code, track set point or independent set of high/low alarm, display dampener, rising or falling set points, conductivity scale, the selection of the inhibitor feed mode, water meter pulse totalizer, and analog output selection.

## 2.3 Key Pad Operation

The Key Pad is easy to use and will guide you through all the sub menus and functions of the controller. Feel free to try out these keys as you read about them. You will not hurt the controller and the values will need to be reprogrammed later anyway.

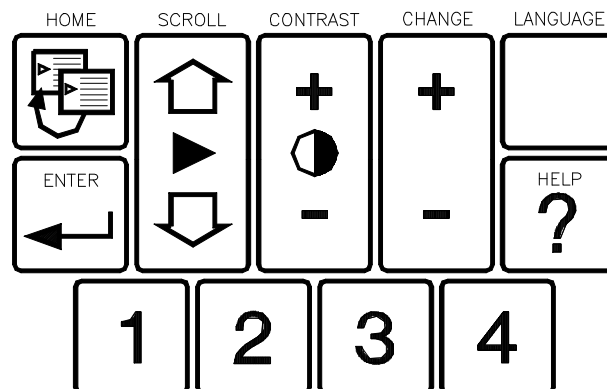

Figure 6

**Home** Press this key to return to previously displayed menu.

**Scroll Up/Scroll Down** Some menus contain more than one page. Press either scroll key to reveal other items on menu displayed. If no other choices are present, nothing will happen when pressing Scroll Keys. The Menu Map supplied with your controller will show you which menus need to be scrolled to show additional choices.

**Contrast Up/Contrast Down** Press these keys to control contrast of viewing screen.

**Arrows** The Arrow Keys are used to change the numerical values associated with the various settings you will be entering. Use “down” arrow to select lower numbers and the “up” arrow to select higher numbers.

**Enter** This key has two functions:

FIRST, within the sub menu, pressing the Enter Key will activate the selection.

SECOND, after selecting the value needed with the Arrow Keys, press the Enter Key to “lock-in” the value. The next value to be set (if one exists) in that particular sub-menu will be displayed.

**Language** This key is used for alternative Spanish language for our international customers.

Spanish is installed as standard feature on these controllers.

**Help** When pressed, this key will display simple instructions for the operation of the Enter, Home, Arrows, and Scroll keys.

**Relays (1-4)** These Hand/Off/Auto (HOA) keys allow immediate control of pumps, solenoid valves, etc. affected by the controller without scrolling through the menus. Press a Relay Key once to force relay on for 5 minutes (an amber light will appear below that key). Press the Relay Key again to force the relay off (a red light will appear below that key, relay will be forced off until key is pressed again). Press the Relay Key a third time to return the relay to auto control (green light will indicate that relay is on, no light indicates that relay is not activated).

## 2.4 Screen Format

The following is a detailed example of how to program your controller. Once you have mastered this exercise, you will be ready to set up the controller to your specifications.

**IMPORTANT!** Please note that in all programming instructions, keypad instructions are presented as all capitals—“ENTER,” items as they appear in the display are presented as all capitals and bold face—“**DISPLAY DATA.**”

For this exercise, you will set “DAY, WEEK, DATE, and TIME.”



Main Menu  
Display Data

1. If not already displayed, press HOME until **MAIN MENU DISPLAY DATA** is displayed.



Main Menu  
Configure

2. Press SCROLL DOWN repeatedly until **MAIN MENU CONFIGURE** is displayed. Press ENTER.



Configure  
Day/Date/Time

3. **CONFIGURE DATE/DAY/TIME** will be displayed. Press ENTER.



date  
01/01/1995 m/d/y

4. The **DATE** menu will be displayed with “month” flashing. Use the ARROW keys to select the current month. Press ENTER.



date  
06/01/1995 m/d/y

5. “Day” will begin flashing. Use the ARROW keys to select the current date. Press ENTER.



6. "Year" will begin flashing. Use the ARROW keys to select the current year. Press ENTER to complete date programming.



7. Press SCROLL DOWN. The TIME menu will display with "hours" flashing. Use the ARROW keys to select current hour (24 hour clock). Press ENTER.



8. "Minutes" will begin flashing. Use the ARROW keys to select current minutes. Press ENTER.

If Biocide Option E or F is present on your controller, you will also configure "Week/Day". If not, configuring "Date/Day/Time" would be complete at step 8 above.



9. Press SCROLL DOWN. The Week/day menu will display with "1st wk" flashing. Use the ARROW keys to select either 1st, 2nd, 3rd, or 4th wk. Press ENTER.



10. "Day" will begin flashing. Use the ARROW keys to select the day of the week you prefer. Press ENTER.

Nothing should be flashing and that completes the Date, Day, and Time programming.

Congratulations, you've done it! All menu programming functions operate in this manner. Feel free to repeat this exercise as often as you like until you are comfortable with the programming Procedure.

Now, press the HOME key repeatedly to return to MAIN MENU, DISPLAY DATA.

### 3. 9300 & 9500 Series

With the controller now installed in a convenient location, apply power and turn the power switch{ XE "power switch" } on. The power LED{ XE "LED" } indicator light will illuminate.

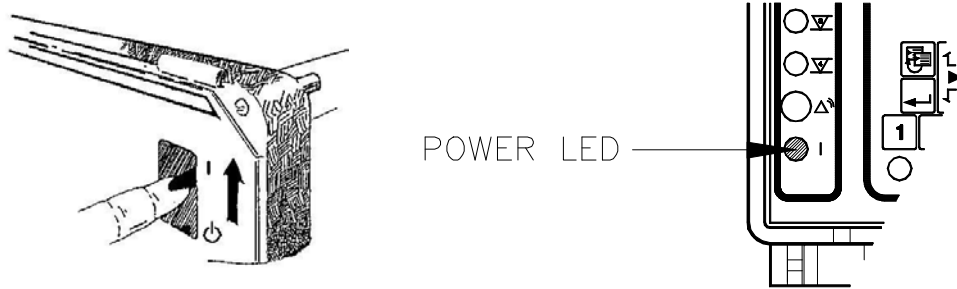

Figure 7

When the controller is powered up, the **PLEASE WAIT** and **SYSTEM WARMING UP** screens are displayed until the internal diagnostics tests are complete, then the **MAIN MENU** is displayed.

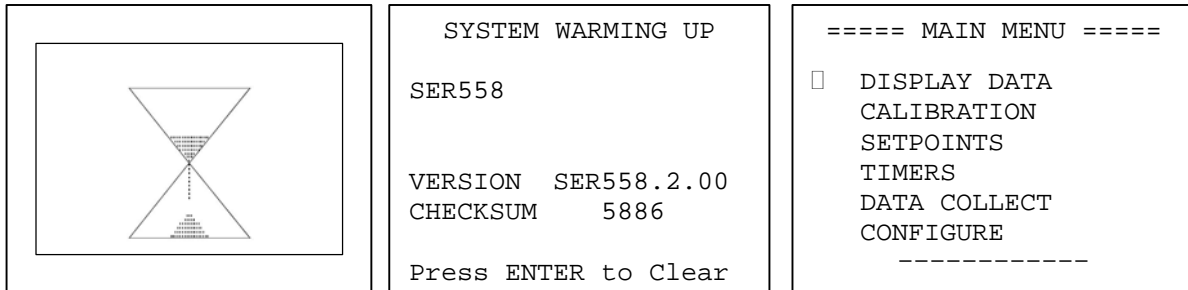
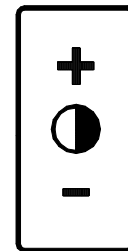

Figure 8

If the display{ XE "display" } contrast requires adjustment, use [CONTRAST{ XE "**CONTRAST**" } UP] or [CONTRAST DOWN] keys on the control panel keypad to adjust the screen for best viewing.



The default values for all control features have been factory set, but you will want to fine tune the controller to meet your specific application.



**WHEN POWER IS SUPPLIED TO THE UNIT, LINE VOLTAGE IS PRESENT ON THE RELAY BOARD LOCATED IN THE BOTTOM OF THE ENCLOSURE EVEN WITH THE LOGIC POWER SWITCH OFF.**

## 3.1 Menu Structure

The Controller's menu structure is designed to be user friendly. The **MAIN MENU** structure diagram shows the first level of all sub-menus in the controller. Not all sub-menus shown here may be present on your controller. The "MENU MAP" supplied on the CD Rom with your controller reflects your specific system with options.

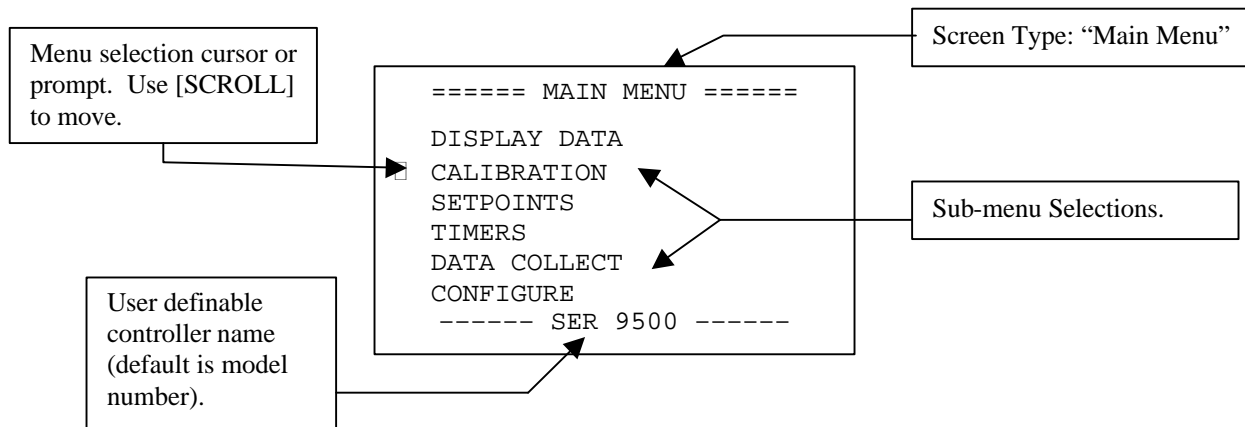







Figure 9



**For help with menu locations, please refer to the "Menu Map" supplied in the literature packet with your controller.**

TIP

-  **Display Data** – Displays date, time, week number, software version, present sensor readings, set-points, system alarms, and relay on times. Use [SCROLL] to move between screens of data manually. Press [ENTER] to unlock the screens and allow them to scroll automatically. This menu displays information only. No settings or adjustments are made through this menu. After five minutes of no keypad activity, the controller will always return to the Display Data screens regardless of the currently active menu.
-  **Calibration** – This menu is for analog{ XE "analog" } input sensor calibration, such as conductivity, pH, and ORP. In this menu, you can choose either 1 or 2 point calibration. The calibration values and "LAST CAL" date stamp are displayed on the menu. You can also use the "TUNE" feature to adjust the current value to a hand held tester's measurement.
-  **Setpoints** – In this menu, you are prompted to enter settings pertaining to setpoints that control the system's operation and associated alarms.
-  **Timers** – In this menu, you are prompted to enter settings pertaining to the Timers. You can select between five different timer types.
-  **Data Collection** – In this menu you make manual recordings of field data.
-  **Configure{ XE "System Configure" }** –In this menu, you are prompted to configure system functions and options to your specific application. System Configure includes such things as time of day, date, security{ XE "security" }, communications, diagnostics, relay on time and factory re-initialization{ XE "initialization" }.

## 3.2 Keypad Operation

The Keypad is easy to use and will guide you through the sub menus and functions of the controller. Feel free to try out these keys as you read about them. You will not hurt the controller and the values will need to be reprogrammed later anyway.

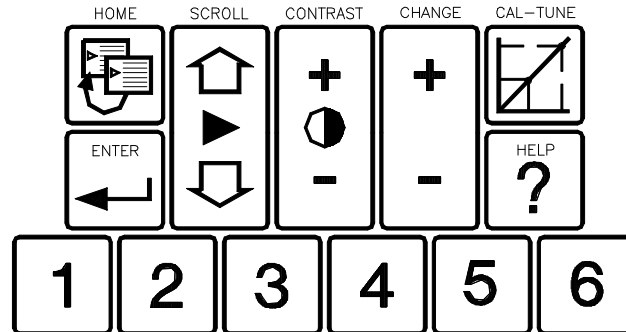
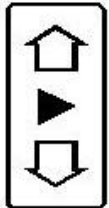

Figure 10



– Press [HOME] to return to the previously displayed menu. Press [HOME] to exit and edit field. Press [HOME] to reject a setting.



– Press [SCROLL] to move the triangular cursor or “prompt” to the next line.

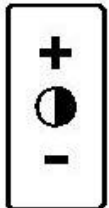

– Press [CONTRAST] to control the contrast of the viewing screen. Pressing [UP] will darken the display{ XE "display" }, pressing [DOWN] will lighten it.

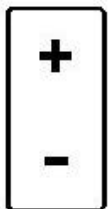

– The Arrow keys are used to change the numbers or values associated with the various settings you will be entering. Use [DOWN] to select lower numbers and [UP] to select higher numbers.



– Enter has three functions:  
 ?? After moving the prompt using the [SCROLL] key to a menu choice, press [ENTER] to display{ XE "display" } the sub menu of the choice you selected.  
 ?? (Within the sub menu), after moving the prompt with [SCROLL] to the selection of your choice, press [ENTER] to edit the selection (the prompt will disappear and the value to be changed will reverse - **a white character is displayed against a black background**).  
 ?? After changing / selecting the value needed with [UP] / [DOWN] press [ENTER] to “lock-in” the value. The prompt and value selected will appear normal.





**NEVER LEAVE A SCREEN IN THE MIDDLE OF EDITING A FIELD! CONTROLLER ACCURACY MAY BE AFFECTED, AND/OR THE CONTROLLER MAY NOT OPERATE PROPERLY. IF YOU FORGET, SIMPLY RETURN TO THAT MENU AND COMPLETE YOUR PROGRAMMING.**



– When pressed, the controller displays a **CAL-TUNE** menu where you can “**TUNE**” the calibration of any of the controllable inputs (e.g., system conductivity, pH ORP, etc.).



– When pressed, this key will display{ XE "display" } simple instructions for the operation of the [ENTER], [HOME], [ARROW], and [SCROLL] keys.



– These Hand/Off/Auto (HOA){ XE "(HOA)" } keys allow immediate control of the relays powering attached pumps, solenoid valves, etc. Press a [RELAY] key once to force the relay on for 5 minutes (an amber light is displayed below that key). Press the [RELAY] key again to force the relay off (a red light is displayed below that key, relay will be forced off until the key is pressed again). Press the [RELAY] key a third time to return the relay to auto control (green light will indicate that relay is on, no light indicates that relay is off).

### 3.3 Screen Format

The controller screens are formatted in a manner that will help you understand what you can and cannot do.

**List Field: “TYPE: 28 DAY”**

A line that has a “ : ” means that you can change a value by selecting from a list.

**Value Field: “RUN TIME = 01:30”**

A line on the screen with an “ = ” sign means that you may change the value.

**Sub-Menu: “<PROGRAMS>”**

A line on the screen with “<\_>” means there is a Sub-Menu that can be accessed.

The following is a sample screen that demonstrates all 3 field types:

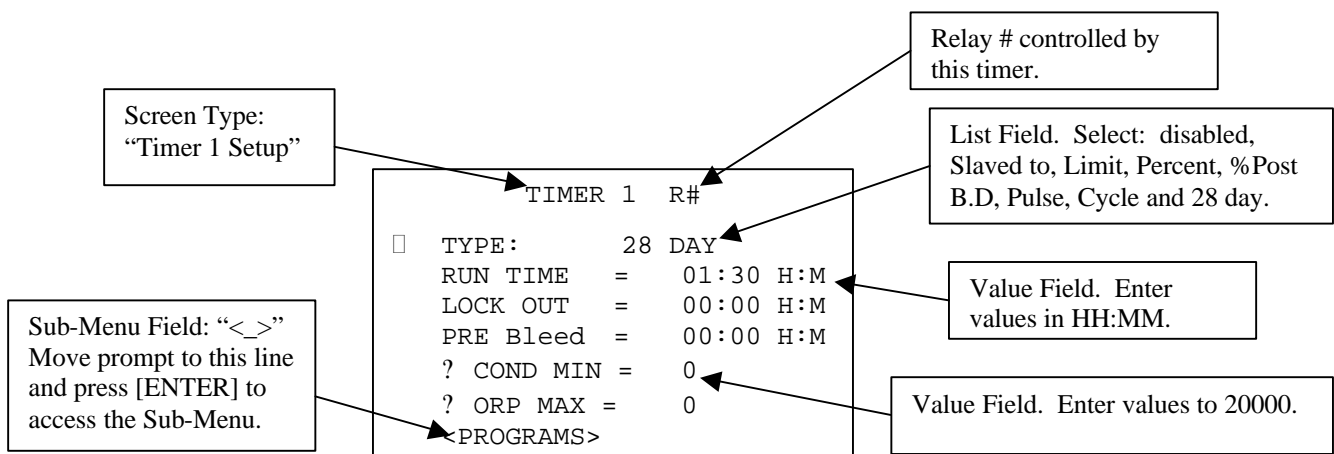

Figure 11

### 3.4 Change Verification

Whenever you make changes to a menu on your controller, a change verification screen appears when you leave that menu. To accept your changes, press [ENTER]. To reject your changes press [HOME].

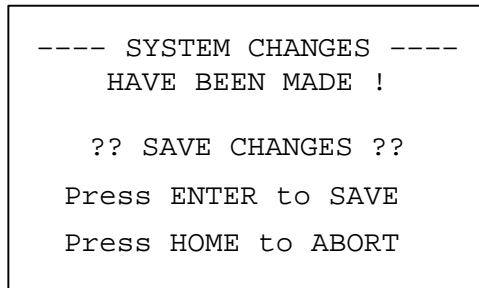

Figure 12

When you accept your changes, the value will be changed and the previous menu will be displayed. When you reject your changes, the menu values will be restored to their original values and the menu will be re-displayed. Press [HOME] to exit the menu.

## 4. Alternate Language

To change to your controllers alternate language:

- ☞ Turn the power “OFF”
- ☞ Open cover and find the dip switch “S1”, located on the main board.
- ☞ Set S1-1 to the “ON” position

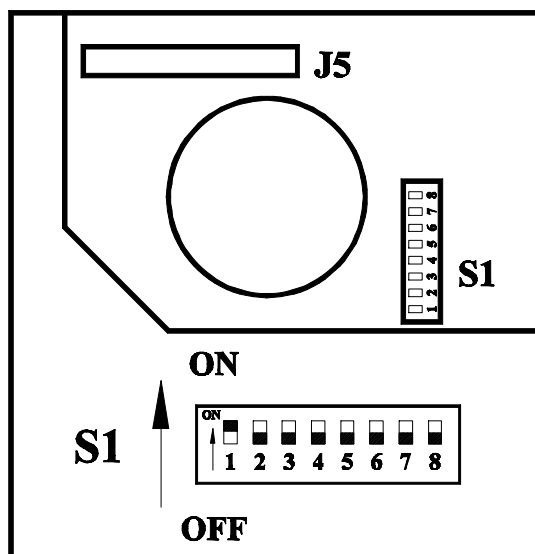

- ☞ Turn power “ON”
- ☞ Perform a “Factory Reinit”, use [SCROLL], [ENTER] and follow these steps

```
===== MAIN MENU =====  
DISPLAY DATA  
CALIBRATION  
SETPOINTS  
TIMERS  
DATA COLLECT  
 CONFIGURE  
-----
```

```
----- CONFIGURE -----  
DATE TIME  
SECURITY  
COMMUNICATIONS  
DIAGNOSTICS  
RELAY TIME  
 FACTORY INITIALIZE
```

```
----- FACTORY INIT -----  
 INITIALIZE to  
          FACTORY DEFAULTS  
  
<ALARM INFO>
```

```
----- FACTORY INIT -----  
  
FACTORY ReINIT WILL  
OVERWRITE ALL  
PREVIOUS SETTINGS  
  
Press ENTER to ReINIT  
Press HOME to ABORT
```

Your controller should now display its alternate language.



NOTE

**The controller will return to Factory Defaults.**

# 5. Factory Default Values



Your controller may not include all of these features

NOTE

	9200	9300	9500
<b>SYSTEM CONDUCTIVITY SCALE</b>	5000 µS/CM	0-5000 (Hardware) µS/cm	0-5000 (Hardware) µS/CM
Set Point Type	RISING/HI	RISING/HI	RISING/HI
Set Point	1500 µS/CM	1500 µS/cm	1500 µS/CM
Set Point Differential	100 µS/CM	50 µS/cm	50 µS/CM
High Alarm	1700 µS/CM	1700 µS/cm	1700 µS/CM
Low Alarm	1300 µS/CM	1300 µS/cm	1300 µS/CM
Alarm Offset	200 µS/CM	-	-
Alarm LED/RELAY/CALLBACK	-	BOTH/BOTH/BOTH	BOTH/BOTH/BOTH
Limit Timer	-	00:00 (HH:MM)	00:00 (HH:MM)
Limit Timer Alarm LED/RELAY/CALLBACK	-	YES / YES / YES	YES / YES / YES
Alarm Delay	00 Sec.	00 Sec.	00 Sec.
<b>MAKE-UP CONDUCTIVITY SCALE</b>	-	0-2000 (Hardware) µS/CM	0-2000 (Hardware) µS/CM
Setpoint Format	-	CYCLES	CYCLES
Setpoint Scale	2000 µS/CM	0-2000 µS/CM	0-2000 µS/CM
Setpoint Ranges	-	0-400 / 401-800 / 801-1200 / 1201-1600 / 1601	0-400 / 401-800 / 801-1200 / 1201-1600 / 1601
Setpoint Range Cycle	-	6.0 / 5.0 / 4.0 / 3.0 / 2.0 Cycles	6.0 / 5.0 / 4.0 / 3.0 / 2.0 Cycles
Setpoint Differential	0.4 Cycles	40 µS/CM	40 µS/CM
High Alarm	700 µS/CM	840 µS/CM	840 µS/CM
Low Alarm	500 µS/CM	360 µS/CM	360 µS/CM
Alarm LED/RELAY/CALLBACK	-	BOTH/BOTH/BOTH	BOTH/BOTH/BOTH
Alarm Delay	-	00 Sec.	00 Sec.
<b>SYSTEM pH SCALE</b>	0-14 pH	0-14 pH	0-14 pH
Set Point Type	RISING/HI	RISING/HI	DUAL
Hi Setpoint	7.2 pH	7.2 pH	7.8 pH
Lo Setpoint	-	-	6.8 pH
Set Point Differential	0.2 pH	0.2 pH	0.2 pH
Alarm Offset	2.0 pH	-	-
High Alarm	9.4 pH	8.3 pH	8.3 pH
Low Alarm	5.4 pH	6.3 pH	6.3 pH
Alarm LED/RELAY/CALLBACK	-	BOTH/BOTH/BOTH	BOTH/BOTH/BOTH
Alarm Delay	-	00 Sec.	00 Sec.
Limit Timer	01:30 (HH:MM)	01:30 (HH:MM)	01:30 (HH:MM)
Limit Timer Alarm LED/RELAY/CALLBACK	-	BOTH/BOTH/BOTH	BOTH/BOTH/BOTH
<b>SYSTEM ORP SCALE</b>	0-1000 mV	0-1000 mV	0-1000 mV
Setpoint Type	FALLING/LOW	FALLING/LOW	FALLING/LOW
Setpoint	400 mV	400 mV	400 mV
Setpoint Differential	50 mV	50 mV	50 mV
High Alarm	500 mV	500 mV	500 mV
Low Alarm	300 mV	300 mV	300 mV
Alarm LED/RELAY/CALLBACK	-	BOTH/BOTH/BOTH	BOTH/BOTH/BOTH
Alarm Delay	-	00 Sec.	00 Sec.
Limit Timer	-	01:30 (HH:MM)	01:30 (HH:MM)

	<b>9200</b>	<b>9300</b>	<b>9500</b>
Limit Timer Alarm LED/RELAY/CALLBACK	-	BOTH/BOTH/BOTH	BOTH/BOTH/BOTH
<b>4-20mA INPUT</b>	-	4-20 mA	4-20 mA
Units	-	NONE	NONE
High Alarm	-	0	0
Low Alarm	-	0	0
Alarm LED/RELAY/CALLBACK	-	BOTH/BOTH/BOTH	BOTH/BOTH/BOTH
Alarm Delay	-	00 Sec	00 Sec
<b>4-20mA OUTPUT</b>	4-20 mA	0-20 mA	0-20 mA
Type		Disabled	disabled
Scale	None	None	None
<b>LEVEL INPUT</b>			
Type	-	-	Level
Active	-	-	Closed
Time	-	-	5 Seconds
Relay Links	-	-	NO / NO / NO / NO / NO / NO
Alarm LED/RELAY/CALLBACK	-	-	YES / YES / YES
<b>FLOW INPUT</b>			
Type	Flow	Flow	Flow
Active	Open	Closed	Closed
Time	1.5 Seconds	1.5 Seconds	1.5 Seconds
Relay Links	-	YES / YES / YES / YES / YES / YES / YES	YES / YES / YES / YES / YES / YES / YES
Alarm LED/RELAY/CALLBACK	-	YES / YES / YES	YES / YES / YES
<b>TIMER</b>			
Type	LIMIT	DISABLED	DISABLED
<b>TIMER: LIMIT</b>			
Run Time	01:30 HH:MM	01:30 HH:MM	01:30 HH:MM
<b>TIMER: PERCENT</b>			
Percent	0%	0%	0%
Percent Minutes	00:10	00:00	00:00
<b>TIMER: PERCENT POST BLEED</b>			
Bleed Percent	0%	0%	0%
Maximum Time	01:30 HH:MM	01:30 HH:MM	01:30 HH:MM
<b>TIMER: PULSE</b>			
Run Time	00:30 MM:SS	00:30 MM:SS	00:30 MM:SS
Pulse Set	10	10	10
Water Meter	-	One	One
<b>TIMER: 28-DAY</b>			
Run Time	01:30 HH:MM	01:30 HH:MM	01:30 HH:MM
Lock Out	00:00 HH:MM	00:00 HH:MM	00:00 HH:MM
Pre Bleed	00:00 HH:MM	00:00 HH:MM	00:00 HH:MM
ORP Maximum	-	0 mV	0 mV
Conductivity Minimum	0 µS/CM	0 µS/CM	0 µS/CM
Program: Start Time	00:00 HH:MM	00:00 HH:MM	00:00 HH:MM
Program: Month	N/A	EVERY MONTH	EVERY MONTH
Program: Week	NO WEEK	EVERY WEEK	EVERY WEEK
Program: Day	FRI	NO DAY	NO DAY

<b>TIMER: CYCLE</b>			
Off Time	-	01:30	01:30 HH:MM
On Time	-	00:30	00:30 HH:MM
Cycles/Day	-	12	12
Program: Month	-	EVERY MONTH	EVERY MONTH
Program: Week	-	EVERY WEEK	EVERY WEEK
Program: Day	-	NO DAY	NO DAY
<b>TIMER: SLAVED TO</b>			
Relay Links	-	NO / NO / NO / NO / NO / NO	NO / NO / NO / NO / NO / NO
<b>WATER METER</b>			
Multiplier	-	100	100
Active	CLOSED	CLOSED	Closed
Time	.80 sec	.80 sec	.80 Sec
Units	NONE	GALLONS	GALLONS
<b>SECURITY</b>			
Master Password	(NONE)	(NONE)	(NONE)
User Password	(NONE)	(NONE)	(NONE)
Calibration	-	NO	NO
Setpoints	-	NO	NO
Timers	-	NO	NO
Data Collect	-	NO	NO
<b>COMMUNICATIONS</b>			
Baud Rate	2400	19200	19200
Interval	1 minute	1 minute	1 minute
Event Driven	-	On	On
Modem Setup String	&FE0V0X4S0=1&D0	&FE0V0X4S0=1&D0	&FE0V0X4S0=1&D0
Alarm LED/RELAY/CALLBACK	N/A	NO / NO / NO	NO / NO / NO
Callback: Active	OFF	OFF	OFF
Callback: Device ID	DEVICE0	DEVICE0	DEVICE0
Callback: Remote Number	(NONE)	(NONE)	(NONE)
Callback: Pager Number	(NONE)	(NONE)	(NONE)
Callback: Pager ID	,1,2,3,4,*001*?#	,1,2,3,4,*001*?#	,1,2,3,4,*001*?#
<b>FACTORY INITIALIZE</b>			
Alarm LED/RELAY/CALLBACK	-	YES / YES / YES	YES / YES / YES

## 6. Standard Sensors:

### 6.1 Cooling Tower Sensors

#### STAINLESS STEEL SENSOR– Part No. 04-600-02

Pressure Rating .....125 PSI (8.6 BAR)  
Temperature Rating ..... 125° F (51.7° C)  
Temperature Compensation ...45°F (7.2°C) to 105°F (40.6°C)  
Construction .....Glass Filled Polypropylene S.S.  
Cell Constant.....0.5

#### pH SENSOR – Part No. 04-040-00

Double Junction  
pH Range ..... pH 0 to 14 (Na+ < 0.1 N)  
Accuracy ..... +/- 0.1 pH Unit  
Response Time ..... < 10 Sec. (95% Response)  
Operating Temp. Range ....23° F (-5° C) to 176° F (80° C)  
Operating Pressure Range ..... 100 psi (6.8 BAR)

### 6.2 Hi-Pressure Sensors

#### CONDUCTIVITY SENSOR – Part No. 04-600-30

Pressure Rating .....250 PSI (17.3 BAR)  
Temperature Rating .....32° F to 212° F (0° C to 100° C)  
Temperature Compensation ....45°F to 105°F (7° C to 40°C)  
Construction .....S.S. with CPVS Insulator  
Cell Constant .....1.5

#### ORP SENSOR – Part No. 04-045-05

ORP Range .....0 - 1000mV  
Response Time .....< 20 sec. (95% response)  
Operating Temperature .....23° F (-5° C) to 248° F (120° C)  
Operating Pressure Rating .....250 psi (17.3 BAR)

#### CARBON GRAPHITE SENSOR – Part No. 04-035-00

Pressure Rating .....125 PSI (8.6 BAR)  
Temperature Rating .....125° F (51.7° C)  
Temperature Compensation .. 45°F (7.2°C) to 105°F (40.6°C)  
Construction .....Glass Filled Polypropylene Carbon  
Graphite  
Thread Size.....3/4" (19.05mm) NPT  
Cell Constant.....1.0

#### ORP SENSOR – Part No. 04-045-00

ORP Range ..... 0-1000 mV  
Response Time .....< 20 Sec. (95% Response)  
Operating Temp. Range ... 23° F (-5° C) to 176° F (+80° C)  
Operating Pressure Range ... .. 50 psi (3.4 BAR) @ 176° F  
(80°C)  
..... 100 psi (6.8 BAR) @ 77° F (25°C)  
Reference Type..... Annular Ceramic  
Reference Sensor ..... Polysaccharide Gel,  
Outer Solution ..... 4 M KCl sat'd with AgCl

#### pH SENSOR – Part No. 04-048-00

pH Range .....pH 0 to 14 (Na+ < 0.1N)  
Accuracy .....+ 0.1 pH Unit  
Response Time .....< 10 sec. (95% response)  
Operating Temperature .....23° F (-5° C) to 248° F (120° C)  
Operating Pressure Rating ...250 psi (17.3 BAR)

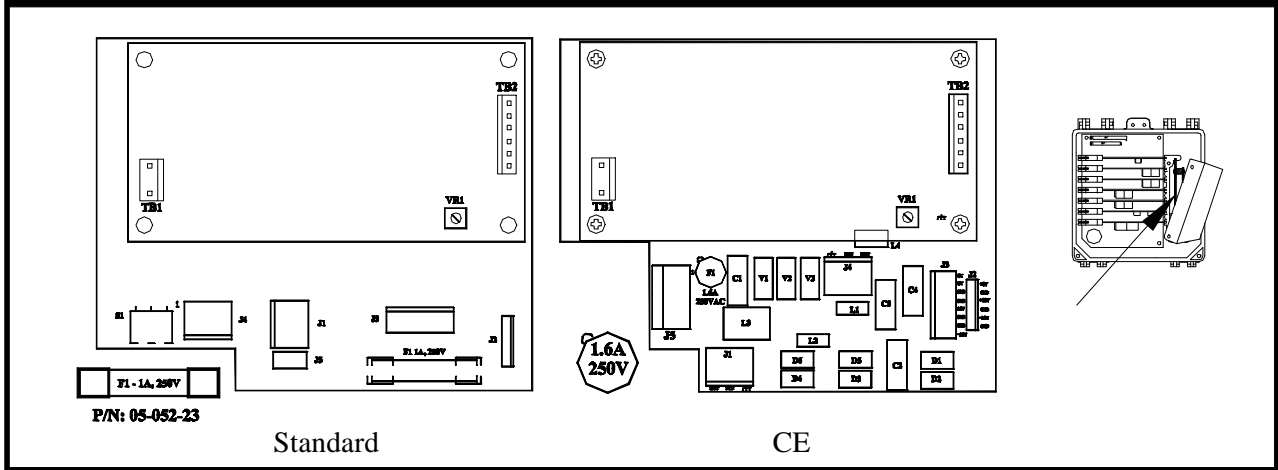
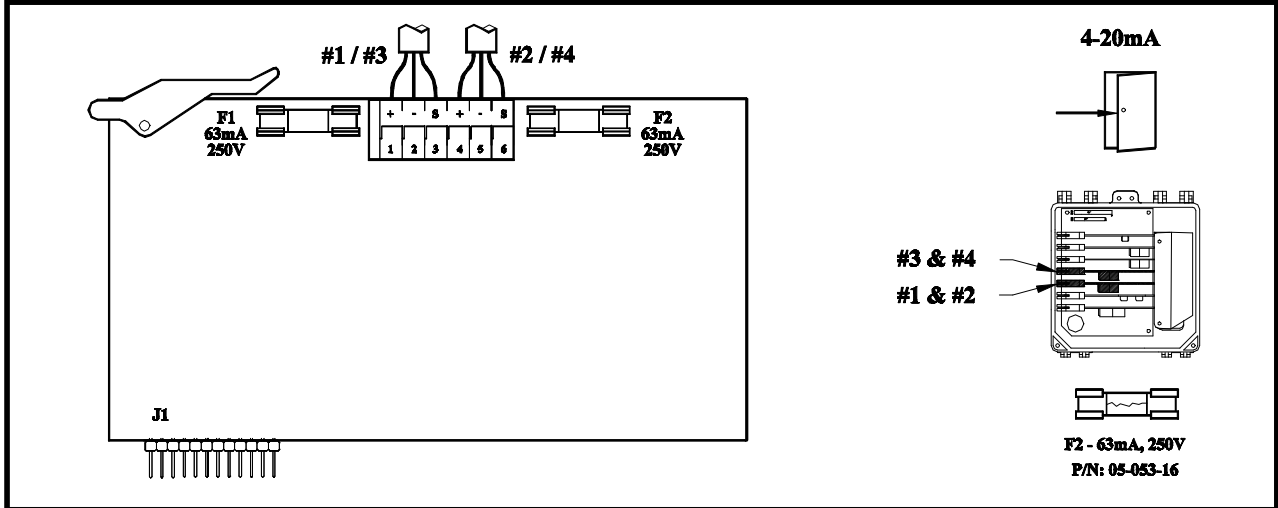
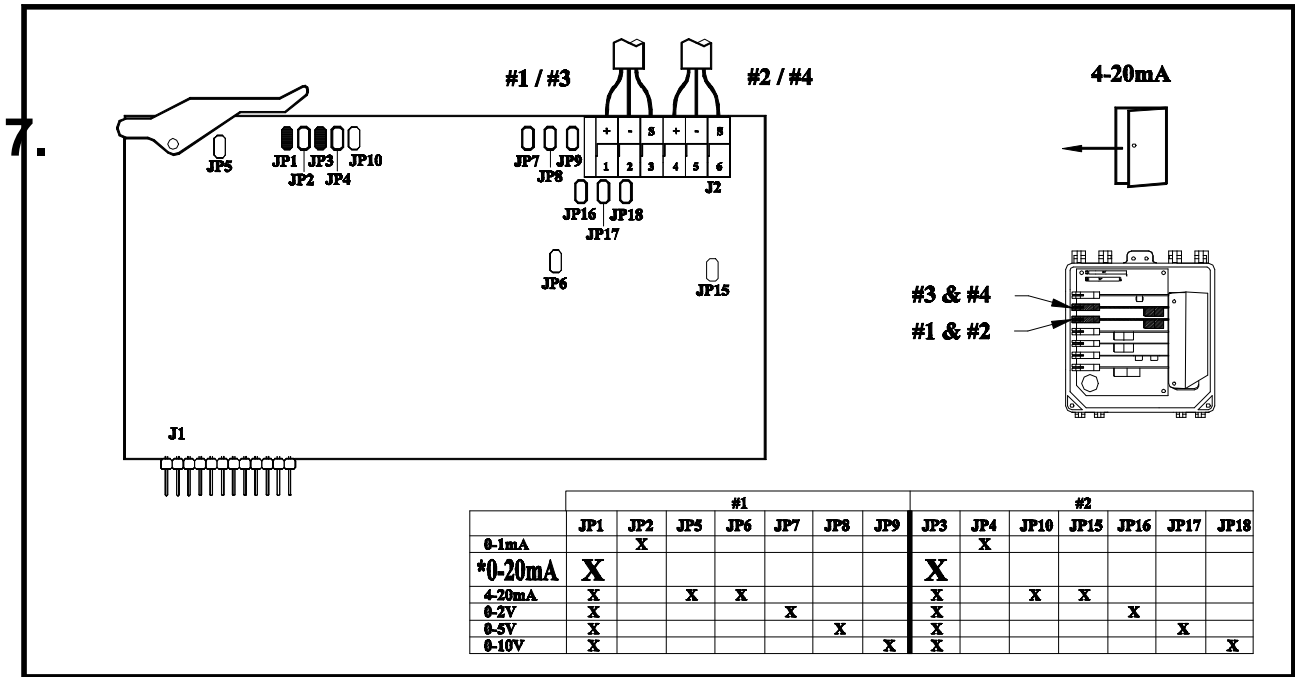



# Specifications

(Factory settings are default values)

## General

Power Input{ XE "Power Input" }	90-250 VAC @ 50/60 Hz 100 VA.
Control Output{ XE "Control Output" }	Line voltage @ 600 VA (5 amps @ 120 VAC) per relay.
Enclosure Pre-wired .....	High impact resistant Polystyrene™ designed to NEMA 4X (IP65), with convenient molded receptacle cords and power cord with molded plug for electrical connections.
Enclosure Conduit{ XE "Enclosure Conduit" }	High impact resistant Polystyrene designed to NEMA 4X (IP65), factory predrilled with easily accessible terminals for hard wiring.
Display.....	Alphanumeric 2 line by 16 character lighted LCD display 9200, 64 X 128 pixel dot matrix backlit display{ XE "display" } (8 line by 20 characters), 9300 & 9500.
Logic Power Switch .....	Recessed front panel.
H/O/A Switches .....	Front panel keypad.
Contrast Adjustment.....	Front panel keypad.
Lockable Viewing Window{ XE "Lockable Viewing Window" }	Standard
Security Code{ XE "Security Code" }	Standard.
Environment.....	Ambient temp. 0°F (-17.8°C) to 122°F (50°C); relative humidity 0 to 95%.
Dimensions{ XE "Dimensions" }	Width 10" (25.40 cm) X height 10" (25.40 cm) X depth 7.08" (17.98)
Controller Weight.....	Max 18 lbs. (8.16 kg)
Shipping Weight.....	Max 22 lbs. (9.98 kg)
Flow Switch or Interlock .....	Connection provided. Function activated by dip switch if mounted flow switch or remote flow switch not ordered with controller.
Inputs{ XE "Inputs" }	8 analog{ XE "analog" } and 8 digital (max - depends on model).
Outputs{ XE "Outputs" }	4 analog{ XE "analog" } and 7 relays (max - depends on model).

## Conductivity Function

Sensor .....	Temperature compensated from 45°F (7.2°C) to 105°F (40.6°C), quick-release 3/4" (19.05 mm) glass filled polypropylene flow tee. Pressure 125 psi (8.6 BAR) @ 125°F (51.7°C).
Setpoint.....	Factory set rising @ 1500 ?S/CM, rising.
Range.....	Selectable 0 to 500, 2000, 5000, 10,000 & 20,000. Factory set @ 5000 ?S/CM.
Accuracy.....	+/- 1% of full scale, at point of measurement, excluding sensor.
Differential.....	Adjustable. Factory setting @ 100 ?S/CM 9200, 50 ?S/CM 9300 & 9500.

High/Low Alarm .....Adjustable. Select track set point or independent. Factory track set point @ +/- 200 ?S/CM (9200). Independently adjustable high and low (9300 & 9500).

Limit Timer{ XE "Limit Timer" } Adjustable in 1 minute increments up to 23:59. Alarm function only.

### **pH Specifications**

Sensor .....Sealed combination type; KCl-AgCl reference with 3/4" (19.05 mm) glass filled polypropylene flow tee, 100 psi (6.8 BAR) @ 176° F(80° C).

Setpoint.....{ XE "caustic" }Factory set Hi 7.8 pH, Lo 6.8 pH.

Range.....0 to 14 pH.

Accuracy.....+/- 1% of full scale, at point of measure, excluding sensor.

Differential.....Adjustable from 0.0 to 14.0; factory setting 0.2 pH.

High/Low Alarm .....Adjustable. Select track set point or independent. Factory track set point @ +/- 1 pH (9200). Independently adjustable high and low (9300 & 9500).

Limit Timer{ XE "Limit Timer" } Adjustable in 1 minute increments up to 23 hours, 59 minutes; factory set at 1:30 hr/min.

### **ORP Specifications**

Sensor .....Sealed combination type; Polysaccharide Gel reference with KCl- AgCl outer. Provided with 3/4" (19.05 mm) glass filled polypropylene flow tee 100 psi (6.8 BAR) @ 77°F (25°C).

Setpoint.....Falling 400 mV.

Range.....0 to 1000 mV.

Accuracy.....+/- 1% of full scale, at point of measure, excluding sensor.

Differential.....Adjustable; factory setting 50 mV.

High/Low Alarm .....Independently adjustable high and low.

Limit Timer{ XE "Limit Timer" } Adjustable in 1 minute increments up to 23 hours, 59 minutes; factory set at 1:30 hr/min.

### **Summary Of LED{ XE "LED" } Indicator Lights**

Power Indicator .....Illuminates green when power is supplied to unit.

Flow Indicator .....Illuminates when flow is present through flow switch.

.....GREEN - Indicates flow

.....RED - Indicates no flow

.....OFF - Indicates disabled

Level Indicator .....GREEN if level OK (switch open).

.....RED if level low (switch closed).

Alarm Indicator .....Flashes red when an alarm condition is present.

Relay Indicators{ XE "Relay Indicators" } AMBER if forced on.

.....RED - If forced off.

.....OFF - If in auto mode and control function is not automatically activated.

.....GREEN - If activated automatically.

## 8. Maintenance

The only maintenance required on your controller is periodic cleaning and calibration of the sensors{ XE "sensors" }. It is recommended that you establish a regular maintenance schedule designed to meet the needs of your particular application. All other service should be performed by factory authorized personnel only. Modifications to or tampering with the circuit level components makes all warranties, written or implied, and/or manufacturer's responsibility for this controller null and void.

## 9. Relay Assignments

### 9.1 Cooling Tower

Model	“C” (J3) [RELAY1]	“D” (J4) [RELAY2]	“E” (J5) [RELAY3]	“F” (J6) [RELAY4]	“G” (J7) [RELAY5]	“H” (J8) [RELAY6]	“T” (J9)
9210	Tower #1 Bleed	Timer #1	-	-	-	-	Alarm
9210XA	Tower #1 Bleed	Timer #1	Bio A	-	-	-	Alarm
9210XB	Tower #1 Bleed	Timer #1	Bio A	Bio B			Alarm
9220	pH	Timer #1	-	-	-	-	Alarm
9220XA	PH	Timer #1	Bio A	-	-	-	Alarm
9220XB	pH	Timer #1	Bio A	Bio B	-	-	Alarm
9230	Tower #1 Bleed	pH	Timer #1	-	-	-	Alarm
9230XA	Tower #1 Bleed	pH	Timer #1	Bio A	-	-	Alarm
931X	Tower #1 Bleed	Timer #1	Timer #2	Timer #3	Timer #4	-	Alarm
932X	Tower #1 Bleed	ORP Feed	Timer #1	Timer #2	Timer #3	Timer #4	Alarm
933XXA	Tower #1 Bleed	Acid	Timer #1	Timer #2	Timer #3	Timer #4	Alarm
933XXB	Tower #1 Bleed	Acid	Caustic	Timer #1	Timer #2	Timer #3	Alarm
951X	Tower #1 Bleed	Timer #1	Timer #2	Timer #3	Timer #4	-	Alarm
952X	Tower #1 Bleed	ORP Feed	Timer #1	Timer #2	Timer #3	Timer #4	Alarm
953XXA	Tower #1 Bleed	Acid	Timer #1	Timer #2	Timer #3	Timer #4	Alarm
953XXB	Tower #1 Bleed	Acid	Caustic	Timer #1	Timer #2	Timer #3	Alarm
954XXA	Tower #1 Bleed	pH	Timer #1	Timer #2	Timer #3	Timer #4	Alarm
954XXB	Tower #1 Bleed	Acid	Caustic	Timer #1	Timer #2	Timer #3	Alarm
955XXA	Tower #1 Bleed	pH	ORP	Timer #1	Timer #2	Timer #3	Alarm
955XXB	Tower #1 Bleed	Acid	Caustic	ORP	Timer #1	Timer #2	Alarm
956X	Open Loop Bleed (e.g., Tower)	Closed Loop Bleed (e.g. Chiller).	Timer #1 (Open Loop System)	Timer # 2 (Closed Loop System)	Timer # 3 (Open Loop System)	Timer #4 (Closed Loop System)	Alarm
957X	Tower #1 Bleed	Tower Bleed #2	Timer #1 (Tower #1)	Timer #2 (Tower #2)	Timer #3 (Tower #1)	Timer #4 (Tower #2)	Alarm

Filename: 7290028.doc  
Directory: C:\DOCUME~1\HMCKEN~1\LOCALS~1\Temp  
Template: C:\msoffice\Templates\puls\_a\_1.dot  
Title: 1  
Subject:  
Author: Pulsafeeder, Inc.  
Keywords:  
Comments:  
Creation Date: 4/11/2002 10:22 AM  
Change Number: 10  
Last Saved On: 10/2/2002 6:31 AM  
Last Saved By: kmalcolm  
Total Editing Time: 50 Minutes  
Last Printed On: 11/1/2002 4:05 PM  
As of Last Complete Printing  
Number of Pages: 27  
Number of Words: 5,011 (approx.)  
Number of Characters: 28,568 (approx.)